

1 POSITION DU CHEVÊTRE ET DIMENSIONS DE LA TRAPPE

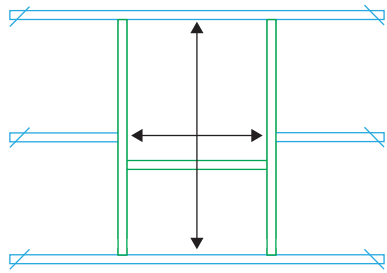

→ A partir de 2 ouvrants, faire un double chevêtre dans le sens longueur.

2 RACCORD FOURRURES

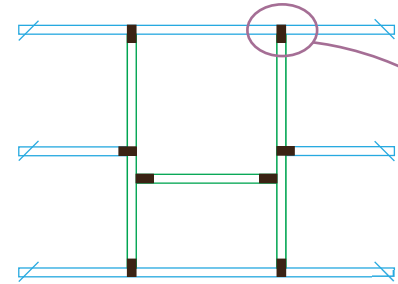

3 POSE DU CADRE DE LA TRAPPE

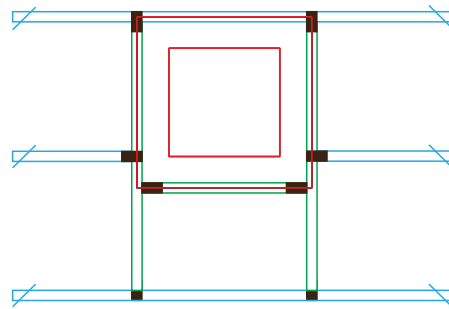

4 POSE DE LA TRAPPE

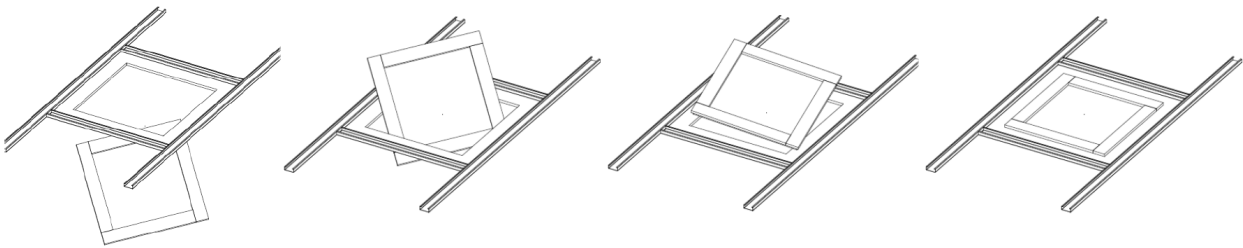

5 FINITIONS

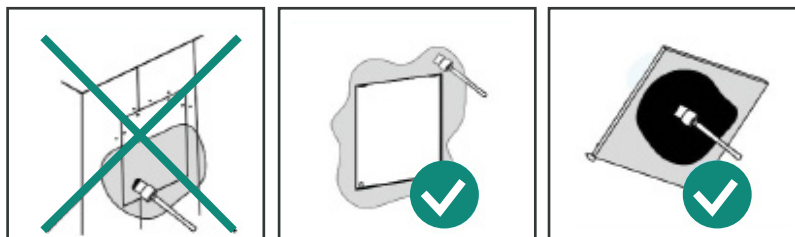

**1** POSITION DU CHEVÊTRE ET DIMENSIONS DE LA TRAPPE

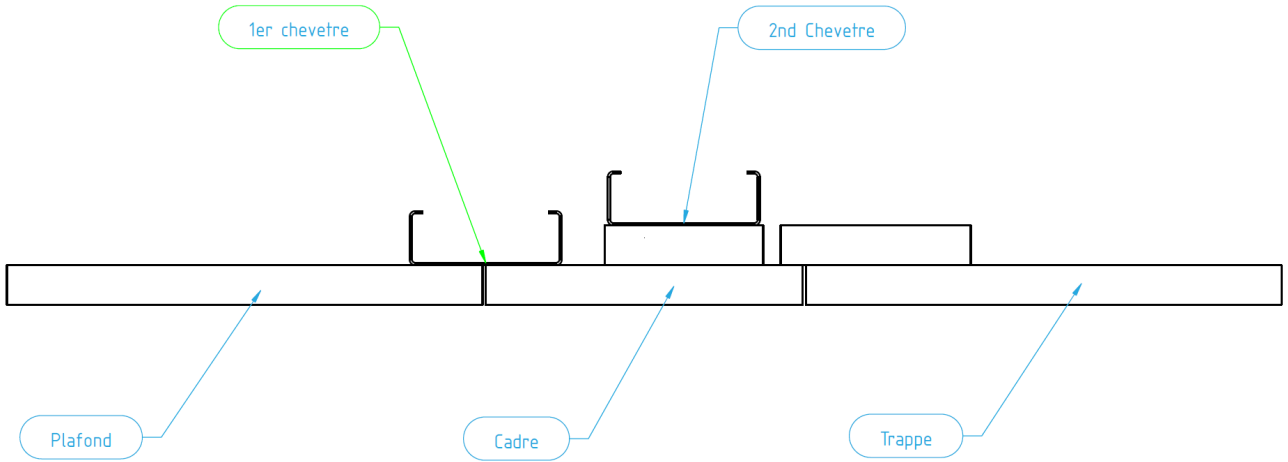

A partir de 2 ouvrants, faire un double chevêtre dans le sens longueur.

**2** MANIPULATION DES OUVRANTS

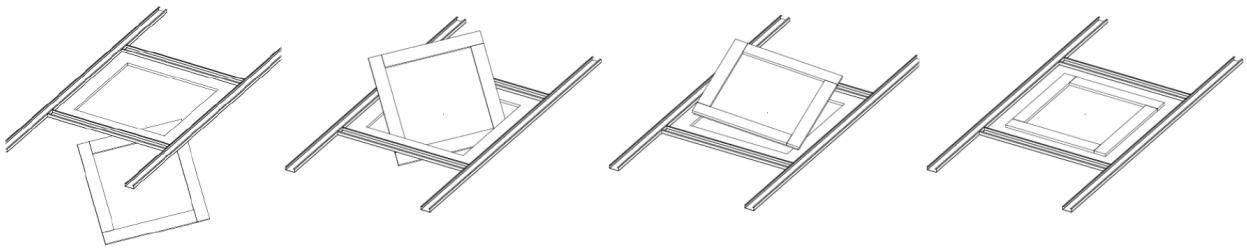

**3** FINITIONS

